

OUR MOST COMPACT HOME LIFT

Aritco 4000
Product catalogue
2020



Aritco aims to make home lifts a natural part of people's everyday lives.

We believe that the definition of a modern home will change - that modern homes and contemporary living will include home lifts. Our journey started 20 years ago, with the simple idea of improving mobility everywhere. Today, Aritco lifts can be found in over 30,000 buildings and private homes around the world.

Simplicity, quality and innovation are the hallmarks of all Aritco's activities. We are constantly seeking new ways to improve the quality, design and user-friendliness of

our products, as well as our environmental impact. Safety and reliability are top priorities, and we follow Europe's strictest quality and safety standards.

All Aritco lifts are developed and produced in Stockholm, Sweden, and we are proud to maintain the highest level of quality in all stages of the process, from design through to final installation in your home.



This catalogue is primarily made for all our partners around the world. The purpose is to show what Aritco can offer in terms of products, options and possible combinations.

Due to continuous product development, all specifications included in this catalogue are subject to change without prior notice. Reservations are made regarding misprints and articles being out of stock.

CONTENTS

Product summary	4
Lift sizes.....	6
Carrier.....	7
Lift colour.....	8
Control panel.....	10
Floor	12
Doors.....	14
Door control	16
Door machinery	18
Door options	19
Lift walls.....	20
Lift wall options	21
Communication.....	22
Drive system.....	23
Fixing the lift	24
European standards and safety.....	25
Recommended sales arguments.....	27
Drawings	28

PRODUCT SUMMARY

Aritco 4000 is the smallest and most compact home lift in our product range and on the market. The lift has been designed to meet all requirements for comfort, space and design. The lift is available in several different sizes, with an option to personalize it with details such as glass walls, a range of varied colours and different materials.

Type of lift:	Home lift intended for installation in private homes. Only to be used in buildings without public access.
Technical compliance:	European Machine directive 2006/42/EC European standard EN 81-41
Drive system:	Patented screw/nut system
Rated speed (max):	0,15 m/s
Travel height:	250 -13 000 mm
Number of stops:	Max. 6 stops per lift
Number of doors:	Max. 6 doors per lift
Number of doors per floor:	Max. 2 doors per floor
Pit:	50 mm (no pit is required when there is a threshold/ramp)
Top height:	Always 2 300 mm
Platform control:	"Hold to run", the destination button must be kept pressed down during the whole ride
Landing control (on door):	One-touch call
Environment:	Indoor
Emergency lowering:	Battery operated emergency lowering
Control voltage:	24V
Motor:	1,5kW
Power supply:	1-phase 230V 50Hz/6.6A/16A slow ¹⁾
Rated load:	250 kg

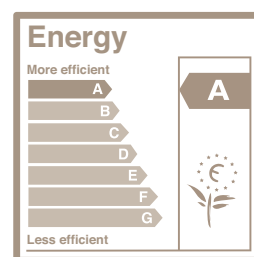

1) Frequency 50 or 60 Hz. Frequency Converter always included.

Aritco 4000

Lift walls
page 20

Doors
page 14

Lift colour
page 8

Carrier
page 7



LIFT SIZE

580 x 805

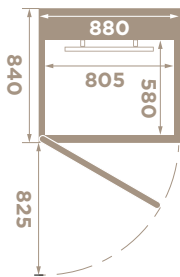
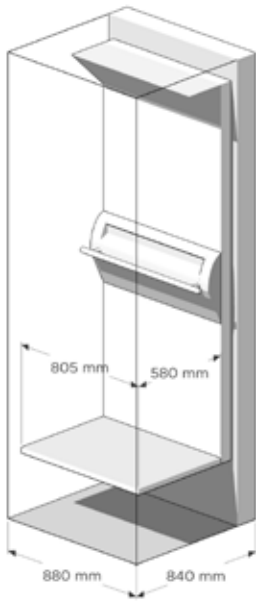

Carrier size: 580 x 805 mm
External dim.: 840 x 880 mm
Rated load: 250 kg / 2 persons

880 x 805

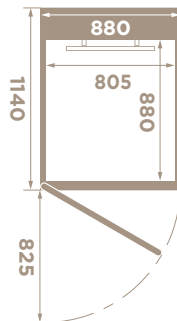
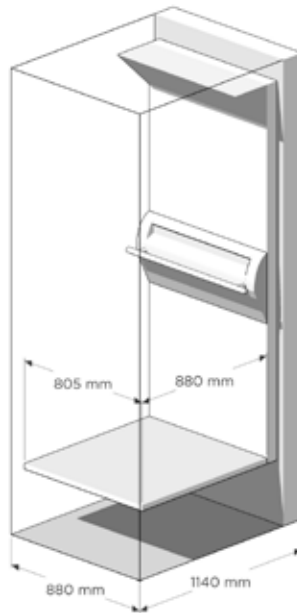

Carrier size: 880 x 805 mm
External dim.: 1140 x 880 mm
Rated load: 250 kg / 2 persons

1080 x 805

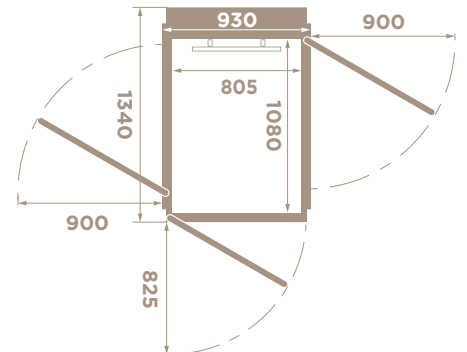
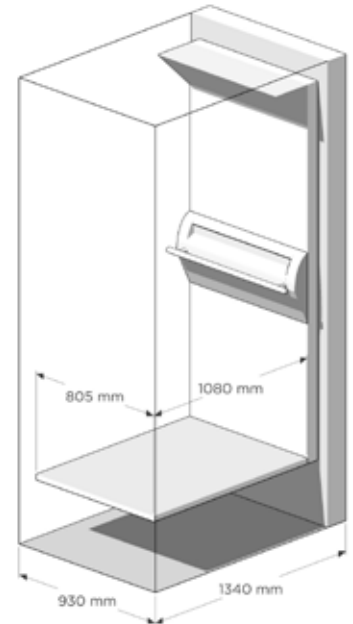

Carrier size: 1080 x 805 mm
External dim.: 1340 x 930 mm
Rated load: 250 kg / 2 persons

(mm)

Aritco 4000 is available in 3 different platform sizes. The rated load is 250 kg and the power supply needed is 230 V 1-phase.

Carrier size: Inner dimensions of the lift
External dimensions: Outer dimensions of the lift (shaft size)
 For detailed drawings see page 28.

CARRIER

The platform is in its basic execution delivered with a side wall (full height) including the destination panel.

It comes with LED lightening and a mirror covering the panel over the destination panel as standard. The panel under the destination panel and the small roof over the mirror is painted in RAL 7042 (grey) as standard, but can be painted in any RAL colour as an option.

MIRROR

Mirror 800 x 970 mm is included as standard.

FOOT BOX

As an option a special plate with a niche can be ordered for the bottom part of the platform. The niche adds a little bit of extra room at the bottom of the platform panel. Size of niche: Depth 80 mm, height: 197 mm, length: 456 mm.



LIFT COLOUR

Aritco 4000 can be painted in any RAL colour from the Chart K7 classic chart (except for pearl and fluoridating colours*).

Aritco 4000 is painted in Traffic White, RAL 9016, as standard. The paint is a soft-textured powder coat with a matt surface (gloss level 12).

The entire lift can be ordered in another colour as an option. It is also possible to order only the doors or walls in a different colour. When another colour is chosen for the doors, all the doors will be supplied in the same colour.

Common colours, see page 9, have shorter lead time and lower price. The rest of the colours from RAL chart K7 classic have longer lead time and higher price.



Standard:

Whole lift painted in standard colour RAL 9016 (Traffic white) except for the panels under the destination panel which are painted in RAL 7042 (Grey).

Full colour option:

Whole lift painted in optional colour (Incl. shaft, doors and the panels under the destination panel.)

Lift partially painted in different colours:

- Lift walls/Shaft in one colour.
- All door blades in one colour.
- All door frames in one colour (Also includes the door faceplate.)
- Panels under the destination panel in one colour.
- One of the above choices or a combination of them.

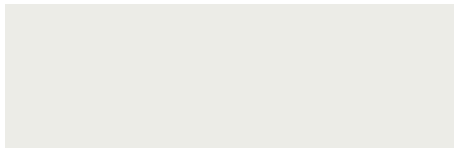

Traffic white - Standard colour
RAL 9016

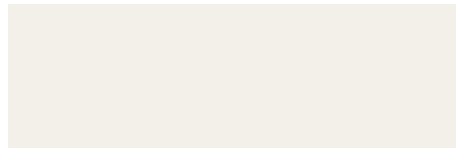

Signal white
RAL 9003



Telegrey 4
RAL 7047

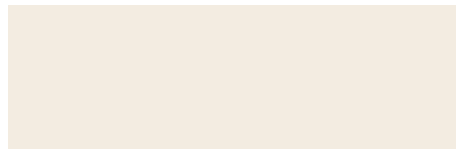

Pure white
RAL 9010



White aluminium
RAL 9006



Light ivory
RAL 1015



Telegrey 1
RAL 7045



Traffic red
RAL 3020



Grey aluminium
RAL 9007



Anthracite grey
RAL 7016



Basalt grey
RAL 7012



Jet black
RAL 9005

Note that the actual colour of the lift may differ from the colour samples pictured above.

- * Any RAL colour means in this case any RAL colour from the 213 colour RAL chart K7 classic except the following colours that are not available;
Fluoridating colours: RAL 1026, 2005, 2007, 3024, 3026, 6038
Pearl Colours: RAL 1035, 1036, 2013, 3032, 3033, 4011, 4012, 5025, 5026, 6035, 6036, 7048, 8029, 9022, 9023

CONTROL PANEL

The destination panel is always placed on the machine side (D-side) of the platform.

It contains the destination buttons, emergency stop, alarm button, autodialer (option), landing indicator (option), Aritco logo, max weight and number of persons allowed. All text and logos are screen printed to ensure good quality.

- Anodized aluminum - standard
- Stainless steel - option

FACEPLATE PANEL

The faceplate panel in anodized aluminum (chemically polished) gives a soft finish to the platform. To prevent any trapping, a safety list is mounted behind the faceplate panel which cuts off the security circuit when pressed down.

ALARM BUTTON

A standard alarm button is always delivered with the lift. When it is pressed a buzzer sounds. This is only a signal to the user that the button is pressed. The alarm button may be connected to an external alarm sounder or an autodialer.



EXTERNAL ALARM SOUNDER

External alarm sounder mounted outside the lift. It is connected to the alarm button and when the alarm button is pressed the external alarm sounder will give a loud signal outside the lift to attract attention in case of emergency. Can be ordered as an option.



DESTINATION BUTTONS

Destination button with background lit frame, which indicates when the button is pressed down (green light). There are no signs on the destination buttons, instead it is possible to have your own text above the destination buttons on the destination panel.

Depending on the number of levels on the lift the destination buttons are either placed horizontally or vertically.

For a 2-3 level lift:

- Maximum 10 characters. Destination buttons are placed horizontally.

For a 4-6 level lift:

- Maximum 7 characters. Destination buttons are placed vertically.

All texts and logos are screen printed on the platform to ensure good quality and flexibility.

The destination buttons will have the same finish as the destination panel.

- Destination panel and destination buttons in aluminum (standard)
- Destination panel and destination buttons in stainless steel (option)

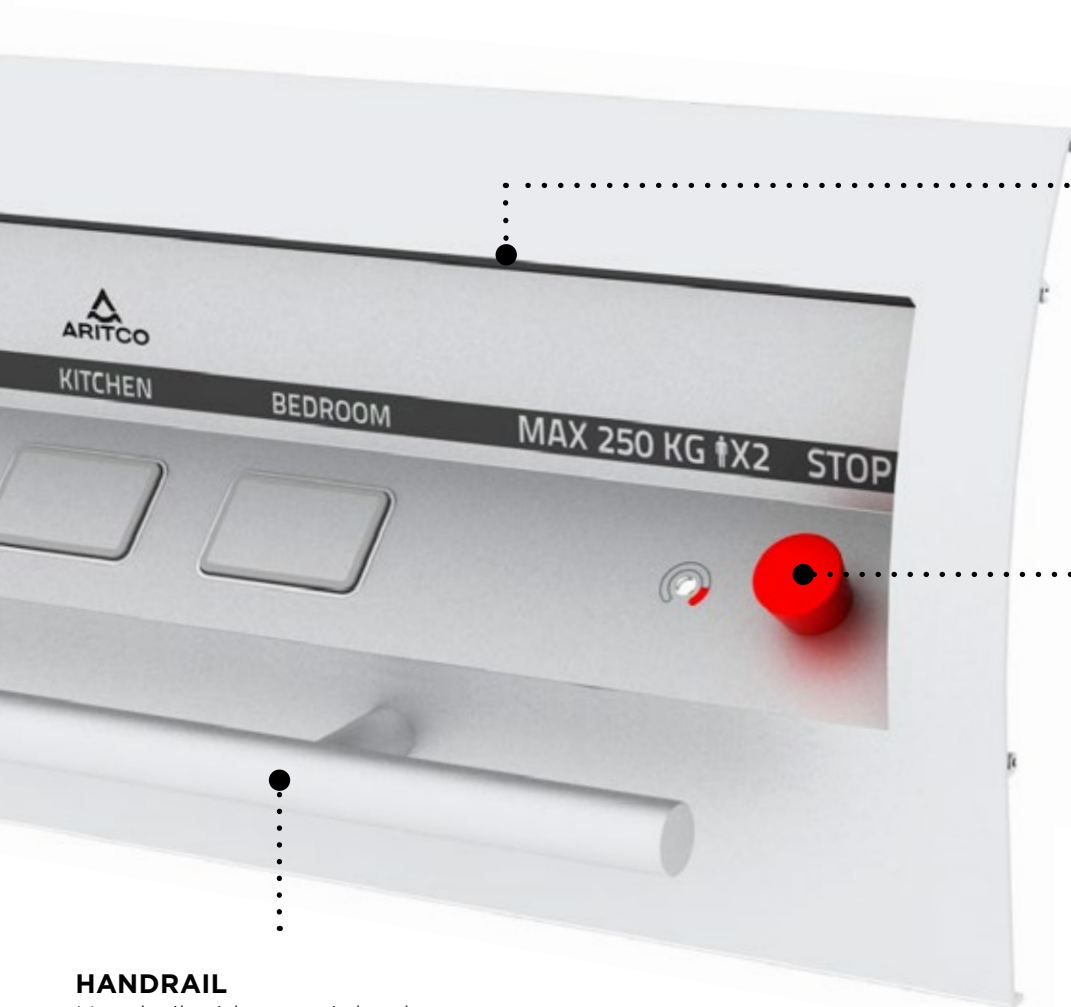

LIGHT

LED lights are installed over the destination panel.

EMERGENCY STOP BUTTON

Button in “mushroom” type for emergency situations. Included as standard.

HANDRAIL

Handrail with a straight shape.

- Anodized aluminum (standard)
- Stainless steel (option)



LANDING INDICATOR

Digital display positioned at the destination panel. It shows which floor the lift is on at the moment. The indicator can also be fitted with a voice announcer available in Danish, Dutch, English, Finnish, French, German, Norwegian, Polish, Russian and Swedish. Voice: Basement, Ground floor, Floor 1-6

The landing indicator can also show information from the system.

- Warning if the batteries are low.
- A bell when the alarm button has been pressed.
- Number of starts and total run time since installation or since last reset.
- A weight symbol will appear if the lift is overloaded.
- If connected to the buildings fire alarm a “Fire” symbol will be shown when alarm is activated.

Can be ordered as an option.

Note that when ordering your own text above the destination buttons, the landing indicator with voice will not be able to say these words.



ASSA

Telemecanique

KEY SWITCH ON PLATFORM

Key switch placed on destination panel. The key switch locks the platform functions and prohibits unauthorized use. One key switch per platform can be provided. The key switch can be serial connected to all destination buttons or to one destination button, i.e. you need to use the key to go to a certain floor.

Two brands to choose from:

- ASSA (Nordic markets only). Aritco only delivers the housing, Aritco does not deliver the locking cylinder.
- Telemecanique

Can be ordered as option.

A close-up photograph of a lift platform. The platform has a dark metal frame and a textured, brownish mat. A small, circular metal fastener is visible on the dark surface above the mat. The text 'FLOOR' is overlaid on the dark surface.

FLOOR

Vinyl or rubber flooring. Choose between the following options. It is also possible to order the lift without a floor, which enables the homeowner to choose and fit their own floor. The maximum thickness of an externally selected floor is 3 mm.



European Oak Vinyl
Standard



Classic Walnut Vinyl
Standard



Oiled Oak Vinyl
Standard

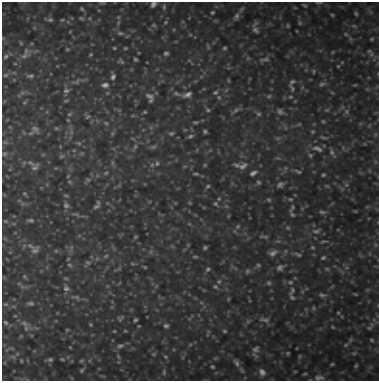

Grey Vinyl
Standard



Checker Stud Black Rubber
Option

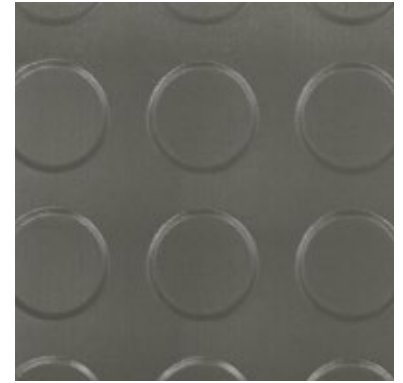

Checker Stud Grey Rubber
Option

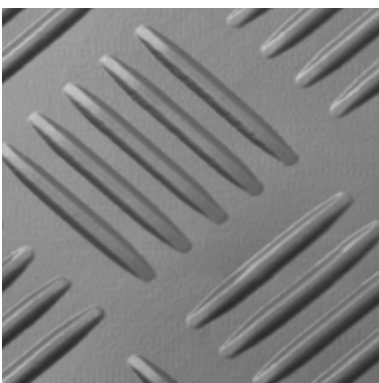

Checker - Grey Rubber
Option



Checker Black Rubber
Option

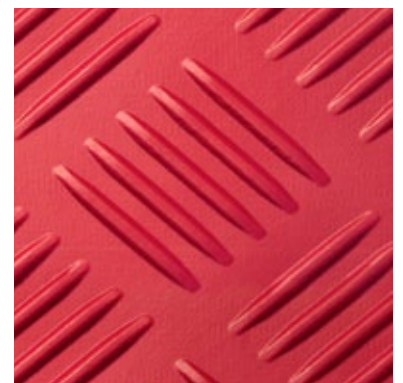

Checker Red Rubber
Option



DOORS

The landing doors installed at each landing are made of galvanized steel and laminated and toughened glass, 8 mm thick.

Note that large glass doors for the B-side are not galvanized, they are made out of cold drawn steel. All doors are painted in RAL 9016 (Traffic white) but can be painted in any RAL colour as an option. The door frame and door blade can be painted in the same colour or the frame in one colour and the blade in another colour. For the same lift all doors must be painted in the same colour. A glassed area according to EN81-41 is standard for all doors. Standard is with clear glass (JT0). Optional is to have tinted glass (JT16) , dark tinted (JT5) or frosted glass (JT23).

The profiles around the glass are made of aluminium. The profiles can be painted in any RAL colour. If the door blade is in RAL 9016 (Traffic white) the profiles can be painted in the same colour as an option. If the door blade is painted in another RAL colour, the profiles will be in aluminium as standard, but can be painted in the same RAL colour as the door blade as an option. Note that aluminium profiles are standard and that painted profiles are an option.

All doors can be left- or right hinged. Doors are always delivered with door frames. It is not possible to order the door or the frame separately. Doors on B side are 800 mm wide.

It is also possible to have doors on the A and C side for platform size 1080 mm. These doors are 900 mm wide.



Large glass door



Double hinged glass door

LARGE GLASS DOOR

Large glass door with one glass window.

Opening widths: 800, 900 mm

Opening heights: 1800, 1900, 2000 mm

The actual height of the door is 40 mm higher since a plate that covers the joint between the door and the frame is mounted on the door.

Glass window (vision): 612x1472 mm (800 mm wide door), 712x1472 mm (900 mm wide door)

Standard: Door blade and door frame in RAL 9016 (Traffic white). Glass window: clear glass (JT0)

Options: Door blade and / or door frame in other RAL colour. Glass window: tinted glass (JT16), dark tinted (JT5), frosted (JT23)

Door opening width	Door opening height	Available for B-side	Available for A/C-side
800	1800 ¹⁾	805	-
	1900 ¹⁾		
	2000		
900	1800 ¹⁾	-	1080
	1900 ¹⁾		
	2000		

(mm)

¹⁾ Not available on top floor since top height of shaft is always 2300 mm

DOUBLE HINGED GLASS DOOR

Double hinged glass doors are made of 17,5 mm laminated glass and always delivered with two internal door openers which opens the doors automatically. If the space in front of the door is limited it is a good solution to use the double hinged glass door.

Opening widths: 800, 900 mm

Opening heights: 2000 mm

The actual height of the door is 40 mm higher since a plate that covers the joint between the door and the frame is mounted on the door.

Door blade: Two blades, 400 mm or 450 mm wide

Glass window (vision): Two glasses, 332 x 1950 mm or 394 x 1950 mm

Standard: Door blade and door frame in RAL 9016 (Traffic white). Glass window in clear glass (JT0)

Options: Door blade and /or door frame in other RAL colour. Glass window in tinted (JT16), dark tinted (JT5), frosted (JT23).

Door opening width	Door opening height	Available for B-side	Available for A/C-side
800	2000	805	-
900	2000	-	1080

(mm)

DOOR FRAME

On the A and C side the door is always delivered with a frame. The height of the frame depends on the door opening height and is always 240 mm higher than the door opening height. On the B-side there is no place for a door frame and the door is mounted without a frame.

Frame size on A/C-side 1160 mm.

Door opening height	Frame height
1800	2040
1900	2140
2000	2240

(mm)

Clear glass
JT0

Tinted glass
JT16

Frosted glass
JT23

Dark tinted glass
JT5

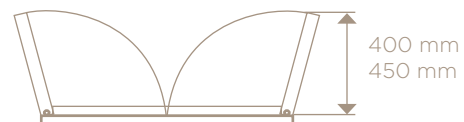

DOOR CONTROL

The door control is either placed on the door frame of each landing door and/or placed away from the lift as an external control.

DOOR CONTROL ON DOOR FRAME

Door control placed on the door frame on the lift. For Aritco 4000 there will only be place for a door faceplate on the A and C side (except when having a double hinged glass door).

CALL BUTTON

The call button comes with a background lit frame which indicates the status of the lift.

- Green light indicates that the lift is at your floor. Lit only on the floor where the platform is at the moment.
- Red light indicates that the lift is occupied. It is busy and you can't call for it.
- The flashing light indicates that the security circuit is broken, e.g. that the emergency button is pressed, the door is open on another floor for more than one minute, the door is blocked or the safety frame is pressed down. The flashing light can also be activated by a sum alarm, more information is then available in the service memory.

The same call button is used when the door control is placed on the door frame, externally or as a radio controlled call button.

CALL BUTTON IN WHITE PLASTIC BOX

Aritco 4000 does not have a door frame on the B-side of the lift and therefore there is no place for a door faceplate on the lift. Standard solution for the B-side on Aritco 4000 is to have the call button in a white plastic box connected to the lift via a cable. Note that the plastic box is white for all lifts, independent of the colour of the the lift.



DOOR FACEPLATE

The door faceplate can be placed directly on the door frame or externally in an external call station box. The door faceplate is painted in the same colour as the door frame. Standard colour is RAL 9016 (Traffic white), if the door frame is painted in another colour the faceplate will be painted in the same colour.

The door faceplate can hold:

- Call button
- Key switch Telemecanique / School locking
- Key switch prepared for Assa / School locking
- Key switch prepared for EUR / School locking

EXTERNAL DOOR CONTROL - PLACED AWAY FROM LIFT

Door control placed away from the lift in an external call station box connected to the lift via a cable or as a radio controlled call button without any cable. When having a door on the B-side there is no frame and thus no place for a door faceplate. Standard solution for the B-side is to have the call button in a white plastic box. It is also possible to have an external call station box. Both connected to the lift with a cable. Note that for double hinged glass doors there is no place for door control on the door frame. External door control must be used.

RADIO CONTROLLED CALL BUTTON

The radio controlled button, placed in a white plastic box, gives the customer the freedom to place the call button wherever they would like within 10 meters from the lift. The radio controlled call button runs on batteries and provides remote controlled access to the lift. The radio controlled call button doesn't indicate the status of the lift. Can be ordered as an option.



KEY SWITCH / SCHOOL LOCKING

Instead of having a normal call button on the door faceplate you can have a key switch. You then need to have the key to be able to call for the lift and to access the lift. Includes school locking function which automatically locks the door 10 seconds after it is closed. Aritco can provide one key switch per door.

Three brands to choose from:

- ASSA (Nordic markets only). Aritco only delivers the housing, Aritco does not deliver the locking cylinder.
- EUR, Aritco only delivers the housing. Aritco does not deliver the locking cylinder.
- Telemecanique

EXTERNAL CALL STATION BOX

The door faceplate can be placed away from the lift and will then be placed in an external call station box. The colour of the external call station box is RAL 9016 (Traffic white). The box can either be mounted exterior on a wall (wall mount) or in the wall so that you only see the door faceplate (flush mounted). The external call station box can be ordered as an option. The standard length of the cable delivered with the external call station box is 1.5 m, as an option it can be 10 m long.

Size flush mount: 82x150x50 mm

Size wall mount: 95x185x50 mm



DOOR MACHINERY

The landing doors are always delivered with either a door opener or a door closer. They are mounted internally (in the door frame so that you can't see it from the outside).

Door opener: Opens and closes the door automatically. Door open time and the opening speed are adjustable.

Door closer: Door is opened manually. The door is closed automatically.

All openers and closers are available for both left and right hinged doors.

When having two doors on the same landing, both doors will be opened at the same time when having door openers.

Door type	Internal door closer	Internal door opener
Large glass door standard	•	•
Double hinged glass door		•

INTERNAL DOOR OPENER

Opens and closes the door automatically. It is built into the door frame and can't be seen from the outside. Can be ordered as option. Standard for double hinged glass doors.

INTERNAL DOOR CLOSER

Closes the door automatically. It is built into the door frame and is invisible from the outside. Includes function to keep door open until the user manually closes the door. Standard for large glass doors.

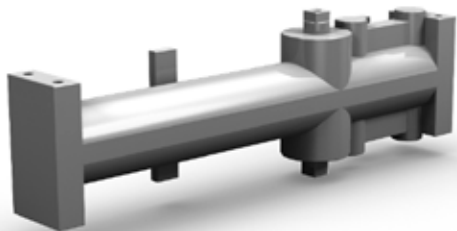
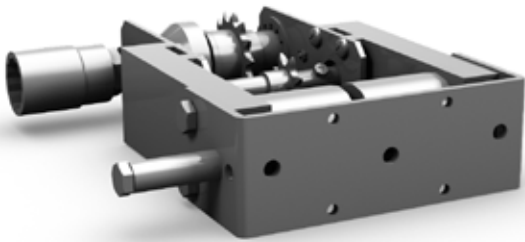

DOOR OPTIONS

LANDING INDICATOR ON DOOR

Digital display positioned at the door frame. It shows which floor the lift is on at the moment. The landing indicator can also show following system information:

- Warning if the lift batteries are low.
- A bell when the alarm button has been pressed.
- Number of starts and total run time since installation or since last reset.
- A weight symbol will appear if the lift is overloaded.
- If connected to the buildings fire alarm a “Fire” symbol will be shown when alarm is activated.



COVER PLATE

If the door control is placed externally and not on the door frame a cover plate that covers the hole in the door frame is delivered with the lift. The cover plate is always delivered with the lift in the same colour as the door frame. Standard colour is RAL 9016 (Traffic white).

THRESHOLD AND RAMP

For all lifts without a pit a door threshold in oak is delivered with the lift. A ramp can be delivered together with the door threshold for easier access to the lift. The ramp is made of galvanized steel, painted in RAL 9016 (Traffic white) as standard. If the shaft is painted in another RAL colour the ramp will be painted in the same colour. Can be ordered as an option.

It is also possible to order the threshold plates in corrugated aluminum instead of oak. In this case a ramp in galvanized steel covered with corrugated aluminum can be ordered as an option for lifts without a pit. A threshold will not be delivered in this case.

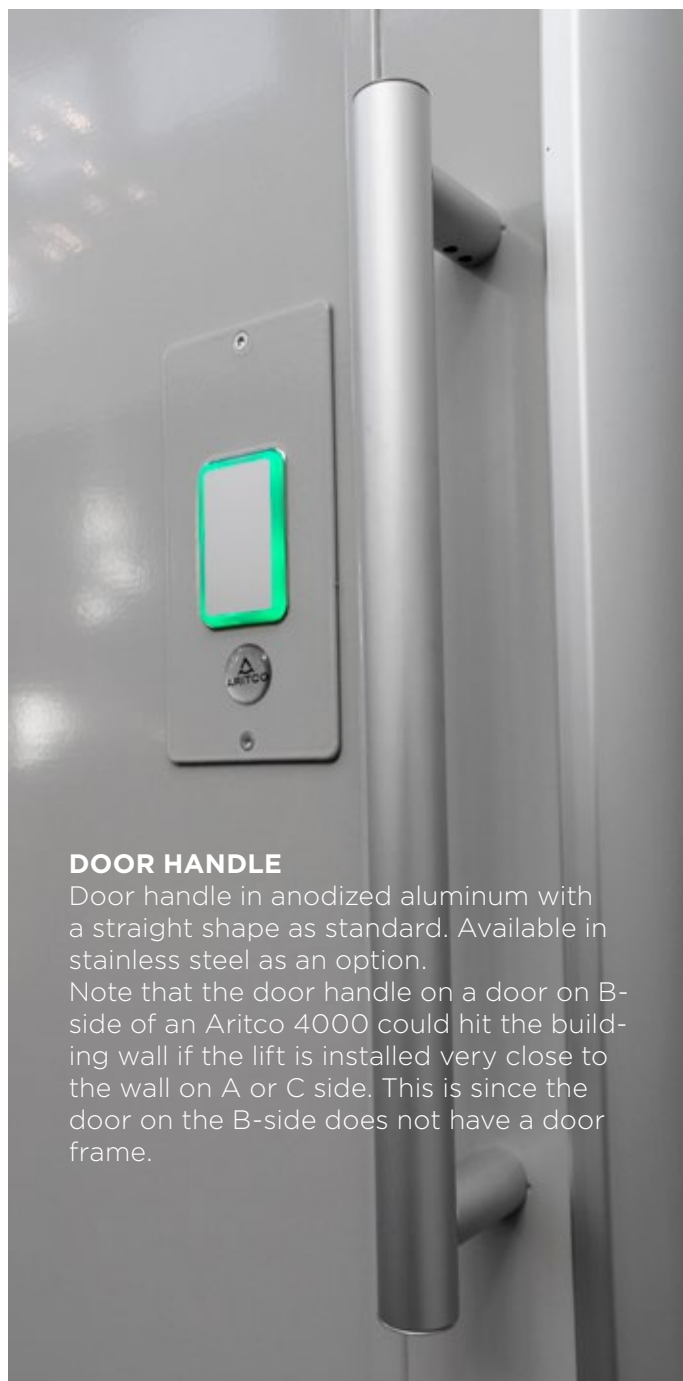
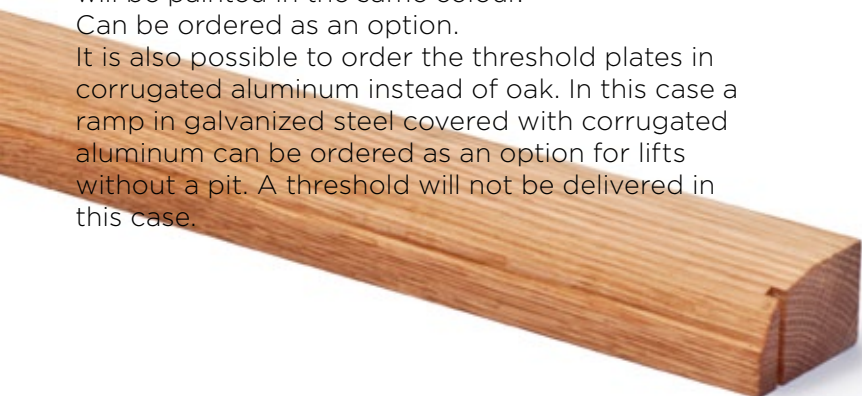

DOOR HANDLE

Door handle in anodized aluminum with a straight shape as standard. Available in stainless steel as an option.

Note that the door handle on a door on B-side of an Aritco 4000 could hit the building wall if the lift is installed very close to the wall on A or C side. This is since the door on the B-side does not have a door frame.

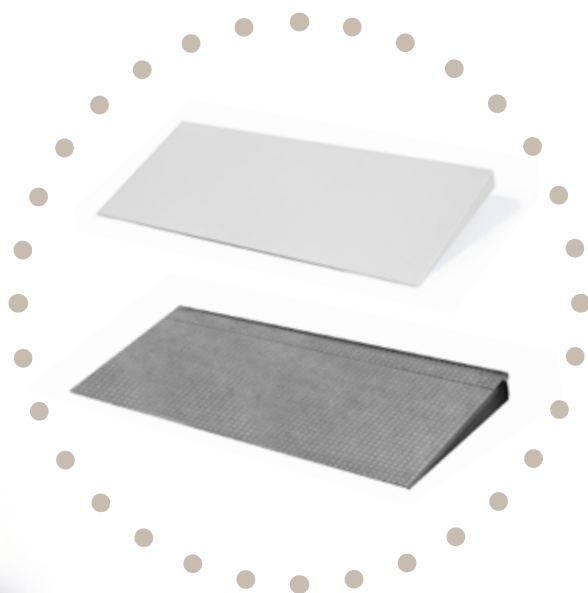

LIFT WALLS

The lift is always delivered with a self supporting shaft.

The top height of the shaft (distance from top floor to top of shaft) is always 2 300 mm. If the lift isn't installed against a wall, machine side cladding can be added on the outside of the lift on the machine side. For all sides except for machine side you can choose to have shaft panels in steel or glass.

INNER CEILING

Aritco 4000 always comes with an inner ceiling, painted in the same colour as the shaft walls. Standard is RAL 9016 (Traffic white). If the shaft is painted in another RAL colour the inner ceiling is painted in the same colour.

SHAFT PANELS

Standard is 25 mm thick shaft panels with EPS (polystyrene) core and steel plates. The panels are painted in RAL 9016 (Traffic white) as standard. If the shaft is painted in another colour the shaft panels will be painted in the same colour. The height of the shaft panel is 575 mm.

GLASS

As an option glass panels with laminated and toughened glass can be ordered. Standard is clear glass (JT0). Option with tinted (JT16), dark tinted (JT5) or frosted (JT23) glass. See page 15. Note that when choosing clear glass the screw will be seen from outside the lift. The glass panels are 8 or 10 mm thick depending on the size of the glass. Glasses which are higher than 1000 mm is always 10 mm. The glasses are fitted in aluminium profiles. These profiles are in aluminium as standard, but can be painted in a RAL colour as an option. For a shaft painted in the RAL 9016 (Traffic white) the profiles can be painted in the same colour. For a shaft painted in another RAL colour the profiles are as standard aluminium. As an option the profiles can be painted in the same RAL colour. Note that this has to be ordered separately.

Shaft panels / glass with aluminium profile:

Height (mm)	Clear glass (JT0)	Dark tinted glass (JT5)	Tinted glass (JT16)	Frosted glass (JT23)
736	•	•	•	•
1472	•	•	•	•
2208	•	•	•	•
Customized ¹⁾	•	•	•	•

¹⁾ Additional cost per mm. Maximum height per glass panel is 2200 mm

MACHINE SIDE CLADDING

The machine side cladding in steel covers the back-side of the machine side if the lift is not mounted against a wall. The machine side cladding can be ordered as an option and can run from bottom to top height. It can also be ordered partly if the lift is partly mounted to a wall. The cladding is painted in same colour as the shaft.

Black plates of sound isolation materials are mounted on the machine side cladding to give the machine side a more esthetical look from inside the shaft and to reduce the noise level.

Size: Travel height plus top height.

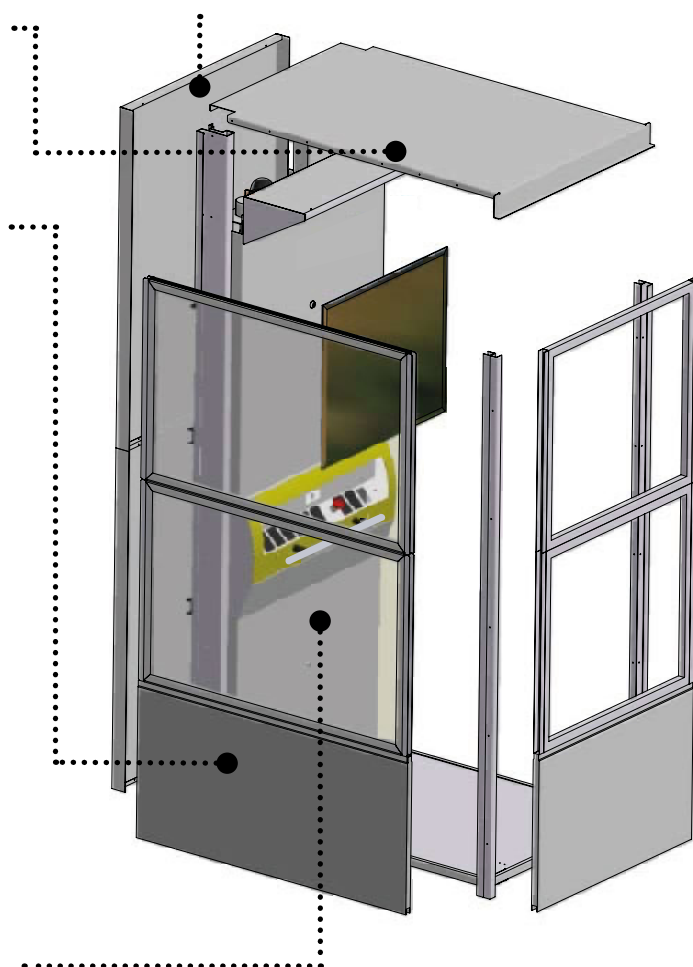

Cover plate for top of the mast

Plate to cover the equipment placed at the top of the mast, such as battery operated emergency lowering). Can be ordered as an option.



LIFT WALL OPTIONS

Mast

Aritco 4000 is always delivered in parts.

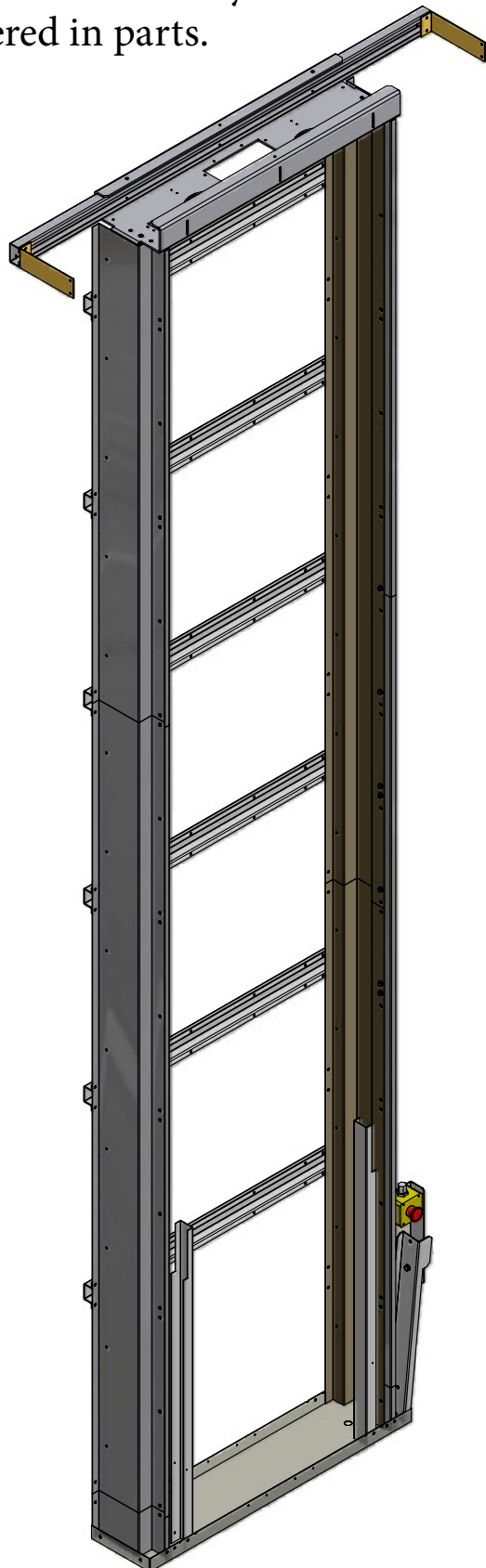

EXTERNAL SERVICE PANEL

A service panel is always placed in the electrical cabinet. It is used to run tests etc., and for emergency running the lift. The electrical cabinet and the standard service panel is mounted in the top part of the shaft and can't be reached from outside. Therefore it is connected to an external service panel (wall mount) which is mounted in a faceplate box. The external service panel must be activated with a 3 edge key before it can be used. Size: 95 x 185 mm



SHAFT SUPPORT FRAME

Used as an alternative fixing method when the mast is not mounted against a wall. One support frame for each floor is needed, except for bottom floor. The support frame is painted in RAL 9016 (Traffic white) as standard. If the shaft is painted in another colour the support frame will be painted in the same colour. The support frame consists of four jointed parts, designed for the 1080 mm platform. However, two of the balks are prepared with small drilled holes so they can be cut to fit the other, smaller platform sizes.



EXTRA ANTI-RUST PROTECTION

In order to protect the lift when exposed to humid environments, e.g. when sea transport or when the packed lift is exposed to humid conditions during transport or at the installation site, the lift is delivered with guides (corrosion class C5). Can be ordered as an option.

COMMUNICATION

Two way communication is mandatory according to EN81-41. Choose from one of the following options or install your own phone.

AUTODIALER

Equipment for emergency calls. Integrated on the destination panel. Dials automatically when the alarm button is pressed. When unanswered after a predefined time, the call is automatically forwarded to the next number.

The autodialer can be equipped with a GSM module (only 2G). Aritco does not supply SIM card.

PHONE

The telephone works as a standard telephone but is intended for emergency calls. The phone is mounted on the platform panel. Equipped with redial memory, mute button and a lamp indicator for on/off. Can be equipped with a GSM module. Aritco does not supply SIM card.

DC CONVERTER

When more autodialers are connected in series on one phone line the power on the phone line is not enough to drive more than one autodialer. In this case, a DC-converter is needed for each lift. The DC-converter 12-24 V is used as external power supply for the autodialer.



DRIVE SYSTEM



BATTERY GUARD

The battery guard ensures that the batteries are not damaged and that there is enough power so that you can run the lift in the case where the power to the lift is cut. It ensures that the lift is turned off (all power consumers are turned off) when the power of the batteries reaches 22 V. This means that when you go on vacation you don't need to turn off the lift even if you turn off the power in the house, the battery saver will ensure that the batteries are not discharged. The battery guard can be ordered as an option.

BATTERY OPERATED EMERGENCY LOWERING

All Aritco lifts have battery operated emergency lowering as standard. You can lower yourself from inside the lift and get out by yourself when there is a power failure. Possible to run the lift to nearest level from the platform (possible to go down) - Executed when pressing a destination button. Can also be run externally from the call button (hold to run) or service box.



POWER SUPPLY

For Aritco 4000 the following is valid:

1-phase 230 V / 6.6A / 16A slow

- Frequency converter with built in soft start and stop
- Frequency 50 or 60 Hz

LUBRICATION

The screw must be oiled at regular intervals.

Automatic Lubrication: Oils the driving screw at regulated time intervals even if the lift is not in use. The lubrication frequency is adjustable. Standard for Aritco 4000.



FIXING THE LIFT

Fixing the lift to the walls of the house.

Details regarding the forces are available in the installation manual for Aritco 4000. Make sure that the entire installation is made in an indoor environment. Force on fixing to support frame (mast) to wall:

- c - c = distance (height) from the floor to the highest fixing into the wall.
- The maximum distance between two fixings or lower floor and the lowest fixing is 4.0 m.
- The minimum distance between lower floor and the highest fixing is 2.0 m.

During installation, before the supporting structure is completed, maximum load on the platform is 250 kg. The force is distributed to the floor through the mast bottom with the area "A" and "B".

Area A carries the weight from mast, drive unit, platform, rated load and over load (75 kg). Most of the load at Area A is distributed in the outer end areas under the rails, i.e. 200+200 = 400 cm² Area B carries the weight from a shaft, including doors and ceiling.

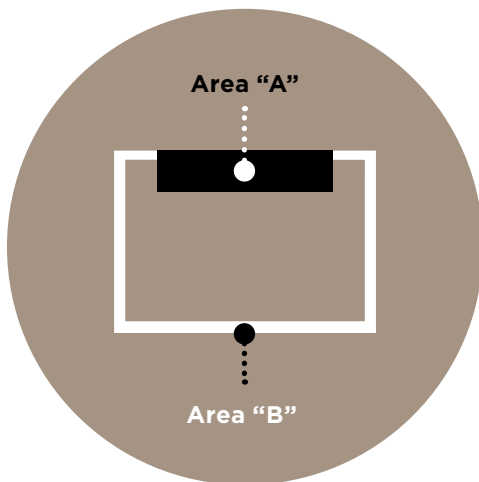
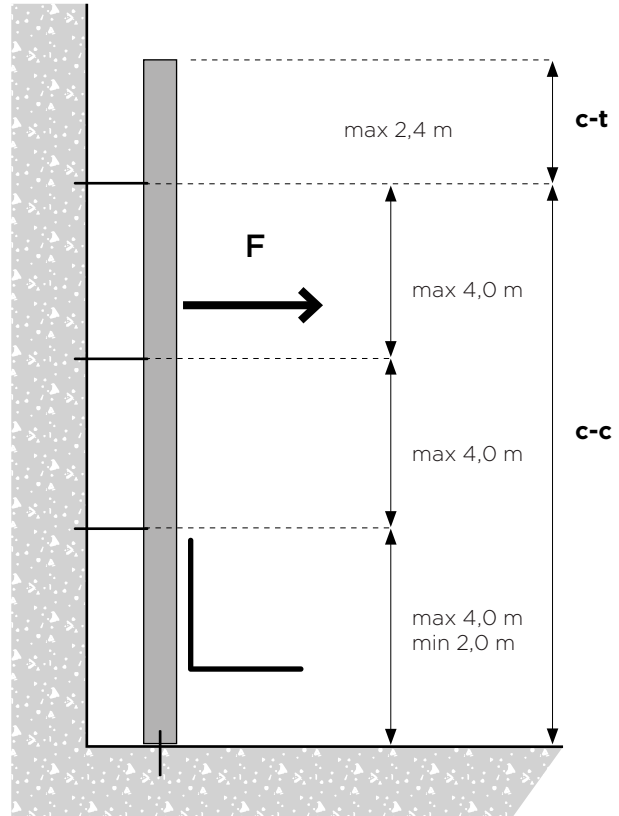

Travel (m)	Area "A" F (kN)	Area "B" Panel shaft F(kN)	Area "B" Glass shaft F(kN)
2	7,2	2,5	3,3
3	7,4	3,2	4,1
4	7,5	3,8	4,9
5	7,7	4,4	5,7
6	7,8	5,0	6,5
7	8,0	5,7	7,3
8	8,1	6,3	8,2
9	8,3	6,9	9,0
10	8,5	7,6	9,8
11	8,6	8,2	10,6
12	8,8	8,8	11,4

EUROPEAN STANDARDS AND SAFETY

Aritco 4000 comply with the Machine Directive 2006/42/EC, by following the harmonized standard EN 81-41. The lifts are also compliant with the Electromagnetic compatibility (EMC) – 2004 and Low voltage Directive 2006/95/EC. The lifts are type approved, CE marked. EI60 – Fire & smoke proof door complies with the lift directive 95/16/EC and EN 81-58. A certificate for respective lift is available on Aritco Cloud.



RECOMMENDED SALES ARGUMENTS

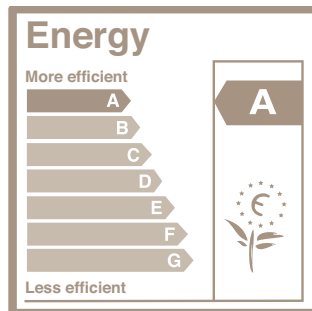
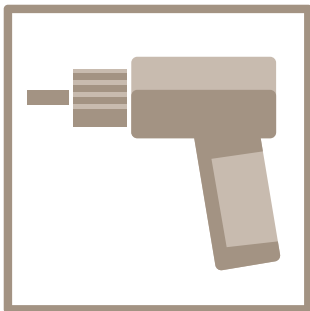

EASY INSTALLATION

Means that the lift is both easy and fast to install. A normal installation only takes two days.

MINIMUM BUILDERS WORK AND SMALL FOOTPRINT

The lift can be installed without a pit, with a ramp (or with a 50 mm pit without ramp). All parts are included in the shaft - no extra machine room or head room needed.

LOW ENERGY CONSUMPTION

Minimum stand-by power consumption 15 W - not more than a computer or a TV. Energy class A as per VDI 4707.

ENVIRONMENTAL PRODUCT DECLARATION

We are the first lift manufacturer with an Environmental Product Declaration. More than 95% of the parts are recyclable.

LOW OPERATION AND MAINTENANCE COST

Lowest on the market.

NO HYDRAULICS, WHICH MEAN NO LEAKAGE OR SMELL

No additional space needed for hydraulic unit.

ROBUST SHAFT

25 mm shaft panels. Robust and resistant to damage.
Good noise and acoustical isolation.

THE LIFT CAN'T FALL DOWN

With the self locking concept, i.e the friction between screw and nut will prevent the lift from falling down. No additional brake system is needed.

YOU CAN ALWAYS GET OUT OF THE LIFT BY YOURSELF

If there is a power failure, you can always get out of the lift by yourself with battery operated emergency lowering. Use the platform buttons and the lift will take you to the closest lower floor and you can open the door and get out by yourself.

DRAWINGS

For exact details for installation see site preparation manual.

Platform 1080 × 805

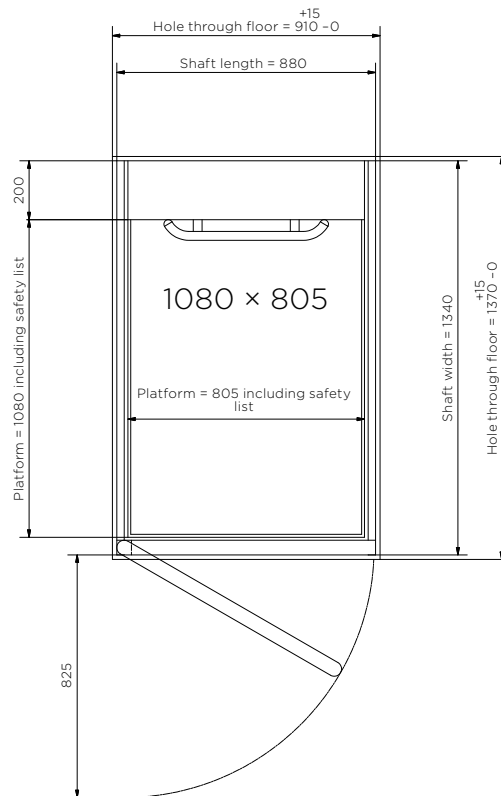
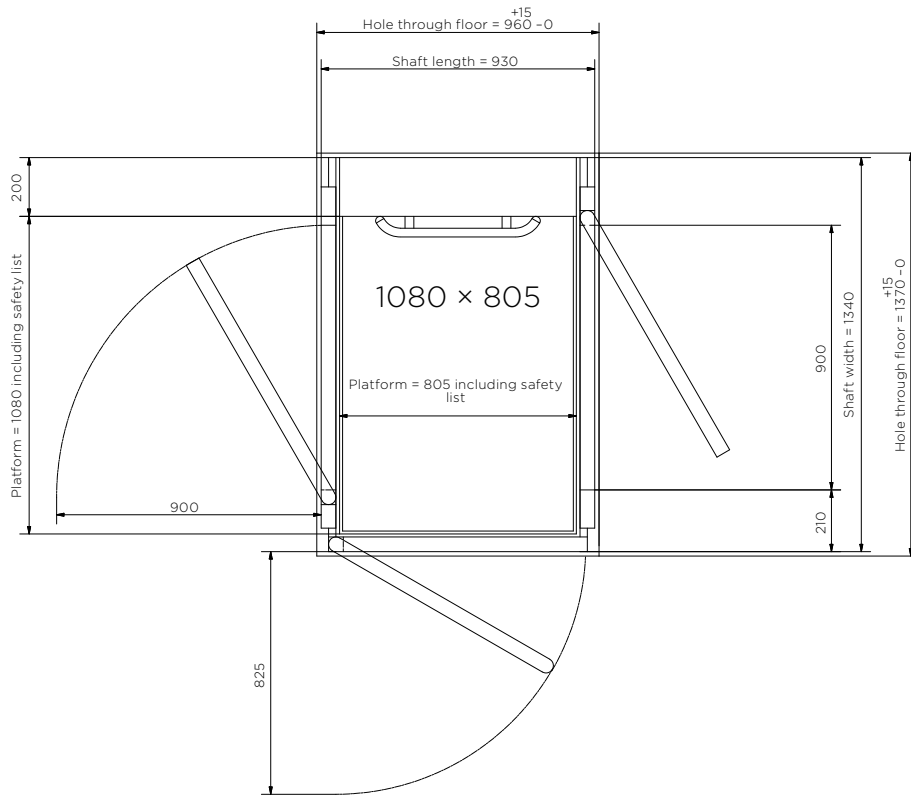

(mm)

Platform 880 × 805

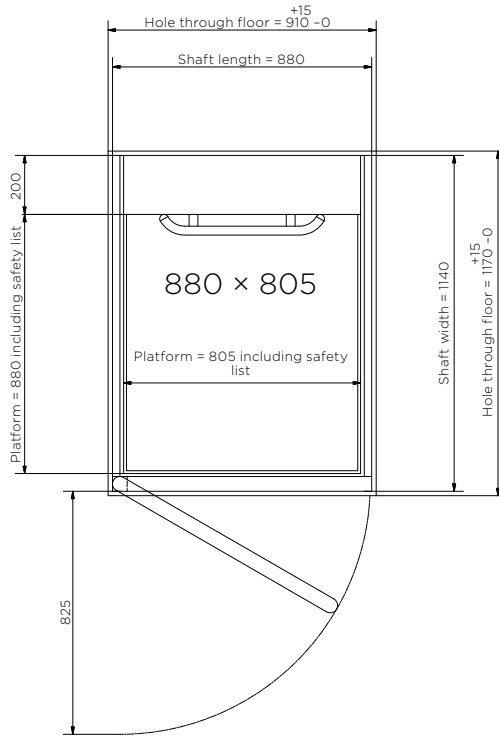

Platform 580 × 805

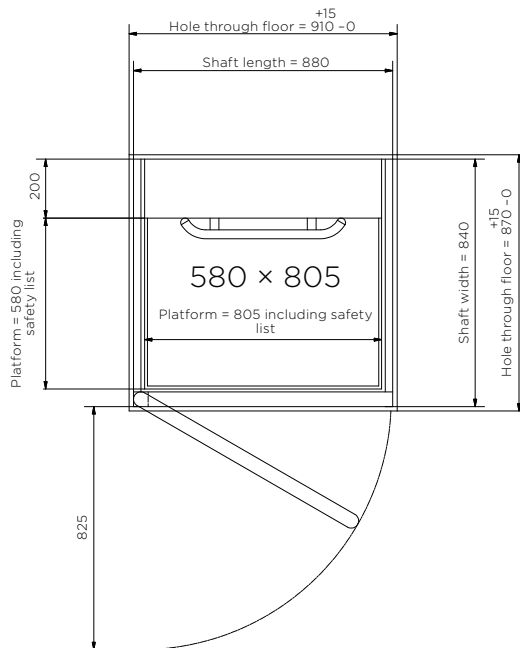

(mm)

In partnership with:

Platinum Lifts Ltd

Henleaze House
13 Harbury Road
Bristol
BS9 4PN
0117 261 0123
info@platinum-lifts.co.uk
www.platinum-lifts.co.uk

Aritco Lift AB
Elektronikhöjden 14, Box 516
175 26 Järfälla, Sweden

T: +46 (0) 8 120 401 00
E: info@aritco.com
www.aritco.com

